

通用模块复用

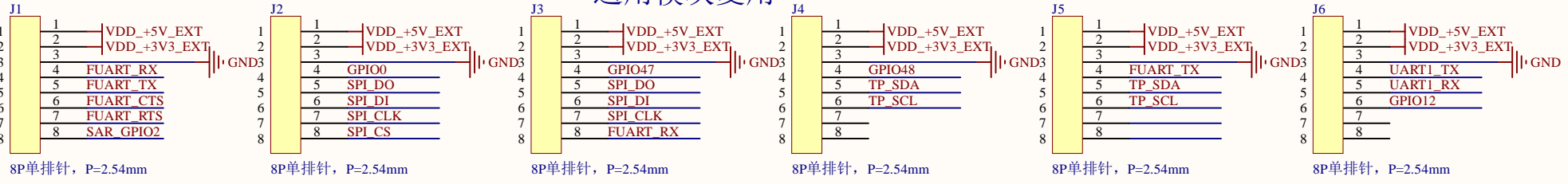

miniPCIE

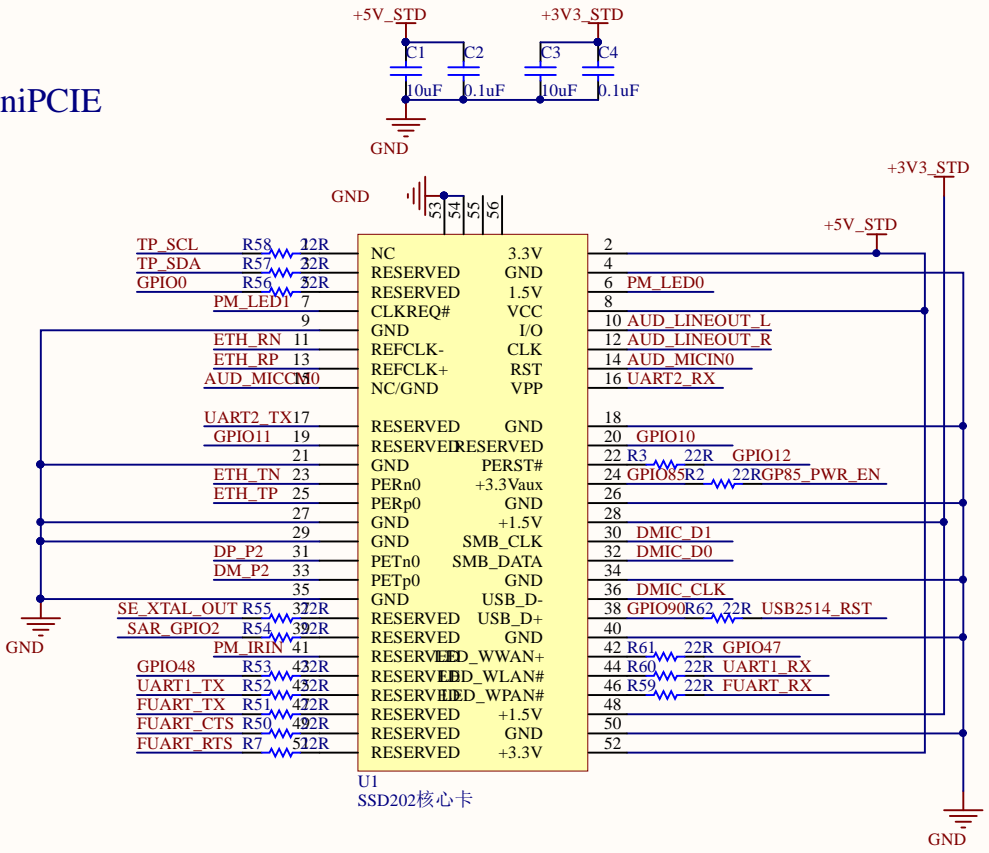

3.3V电源控制

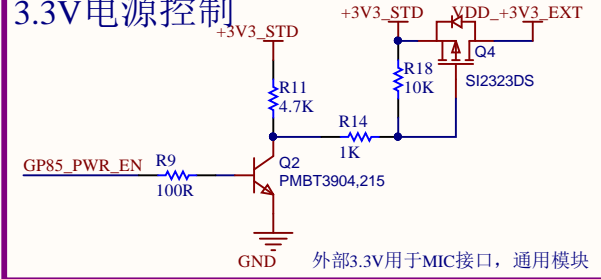

DMIC扩展

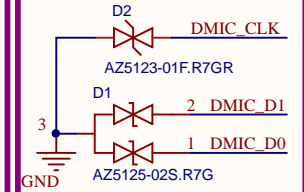

DMIC_ESD保护

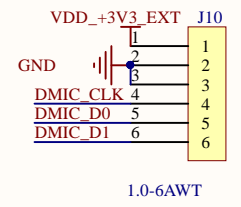

5V电源控制

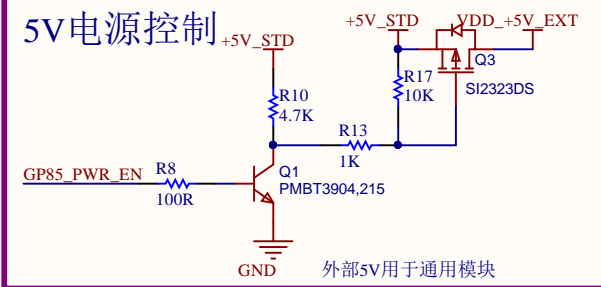

I2C上拉

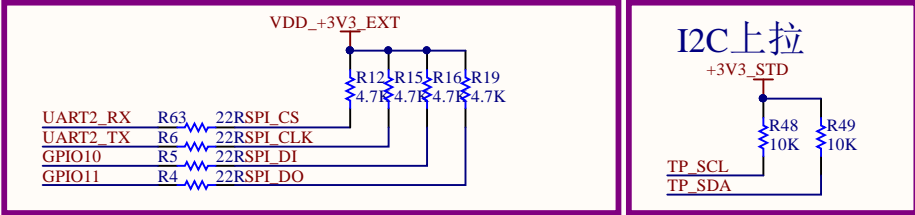

Title		
Size	Number	Revision
A4		
Date:	2022/1/25	Sheet of
File:	H:\东山I1壹号开发板\...MINIPCIE.Sch Drawn By:	