

Title		
Size	Number	Revision
A4		
Date:	2023/3/29	Sheet of
File:	H:\DongshanPI-PicoW...\POWER.SchDoc Drawn By:	

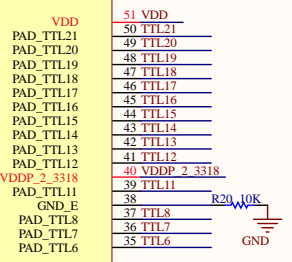

Title		
Size	Number	Revision
A3		
Date:	2023/3/29	Sheet of
File:	H:\DongshanPI-PicoW\...\SSD210_SchDwgDrawn By:	

### SSW101B时钟

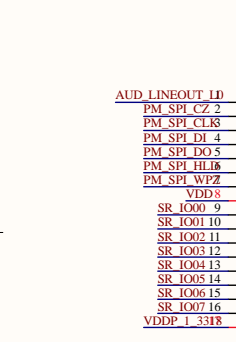
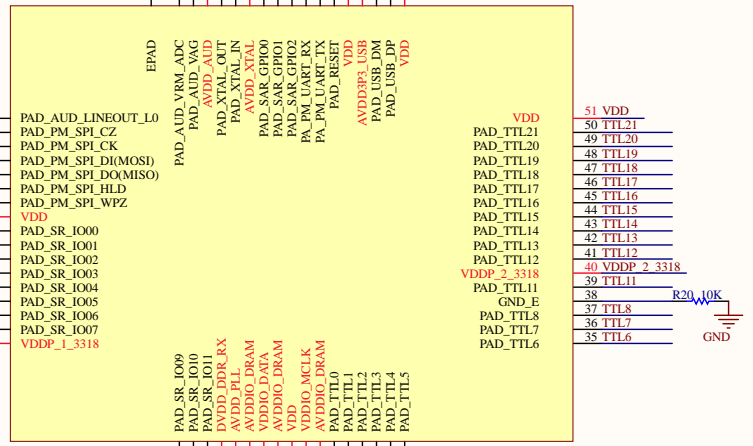
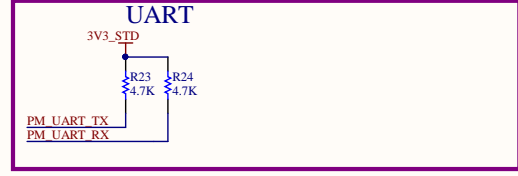
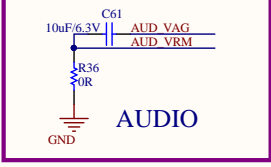
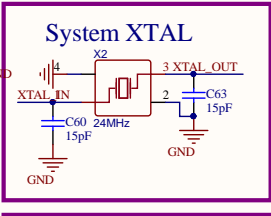
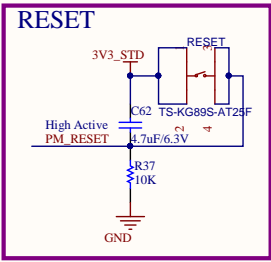
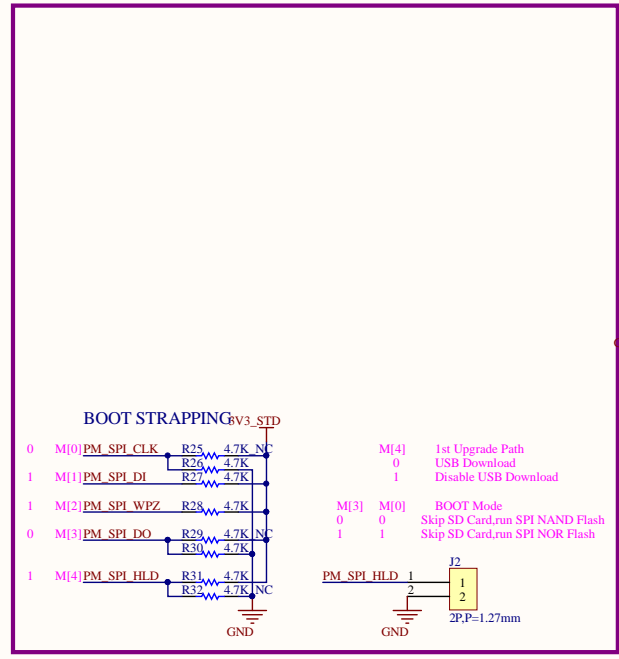
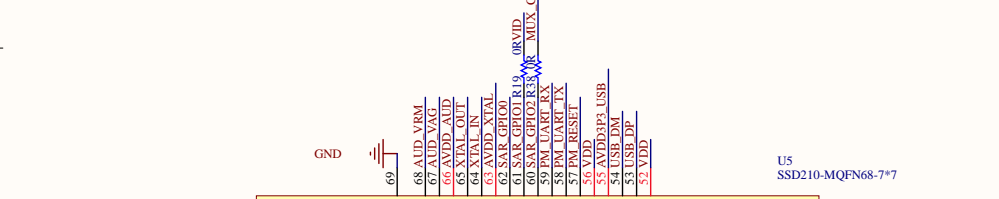
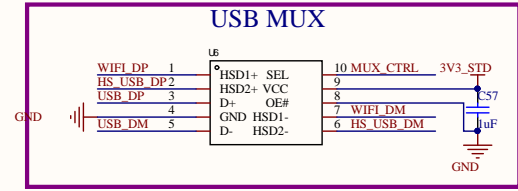
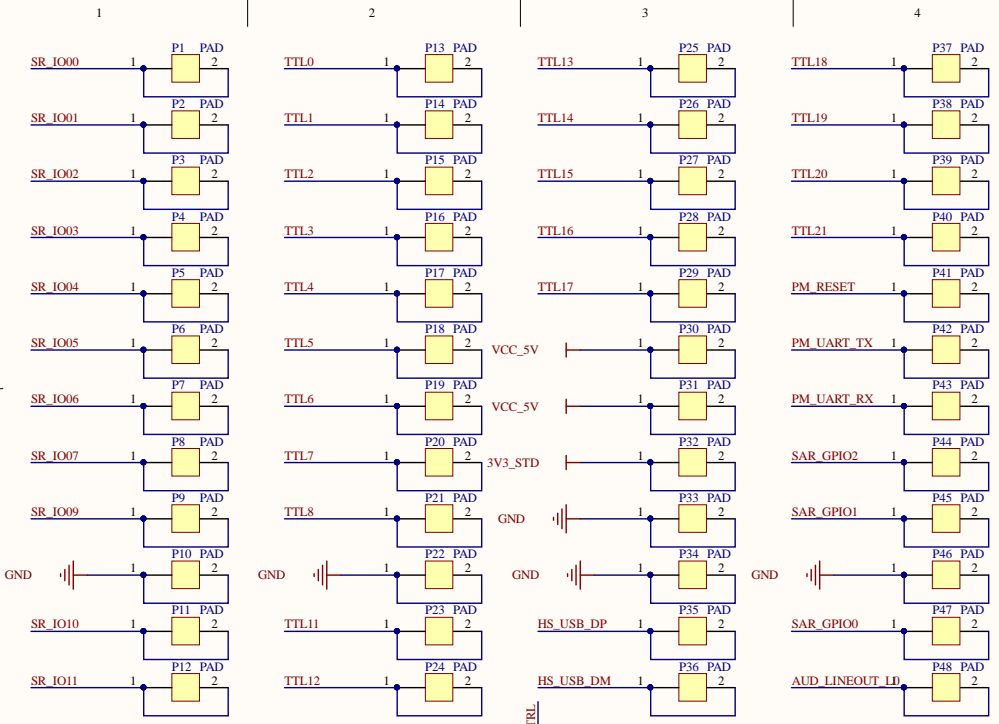
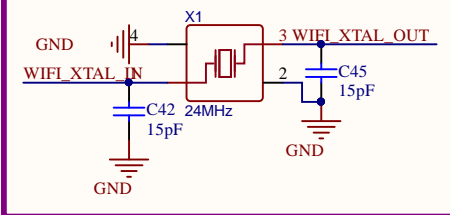

功率: 3.3V<sub>v</sub>>=400mA

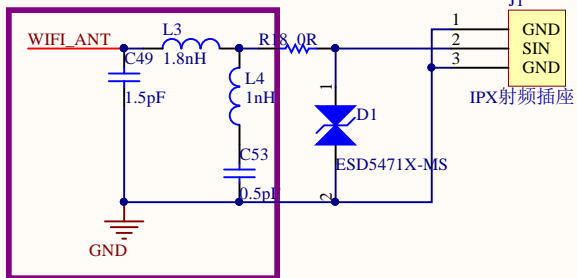
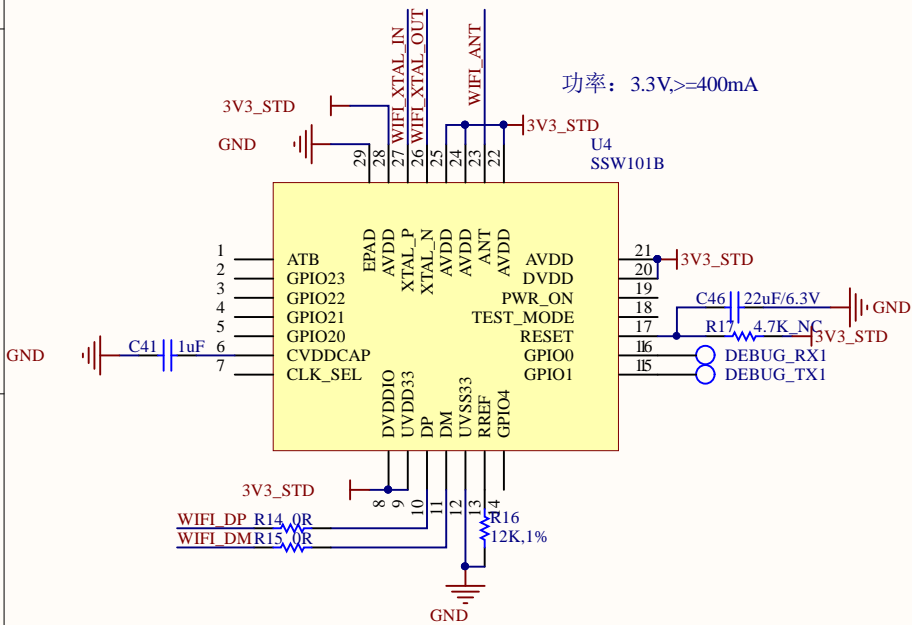

### Decouple

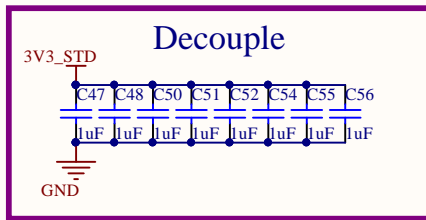

Title		
Size	Number	Revision
A4		
Date:	2023/3/29	Sheet of
File:	H:\DongshanPI-PicoW...\SSW101B.SchDoc Drawn By:	